

## ***Dynamic Model of Linear Induction Motor Considering the End Effects***

*Dr. Haroutuon A. Hairik*                      *Mohammed H. Hassan*  
*University of Basrah-College of Engineering Department of Electrical  
Engineering*

### **Abstract**

In this paper the dynamic behavior of linear induction motor is described by a mathematical model taking into account the end effects and the core losses. The need for such a model rises due to the complexity of linear induction motors electromagnetic field theory. The end affects by introducing speed dependent scale factor to the magnetizing inductance and series resistance in the d-axis equivalent circuit. Simulation results are presented to show the validity of the model during both no-load and sudden load change intervals. This model can also be used directly in simulation researches for linear induction motor vector control drive systems.

## Nomenclature

$v_{ds}, v_{qs}$  d,q axes primary voltages in the synchronous reference frame.

$i_{ds}, i_{qs}$  d,q axes primary currents in the synchronous reference frame.

$v_{dr}, v_{qr}$  d,q axes secondary voltages in the synchronous reference frame.

$i_{dr}, i_{qr}$  d,q axes secondary currents in the synchronous reference frame.

$\lambda_{ds}, \lambda_{qs}$  d,q axes primary flux.

$\lambda_{dr}, \lambda_{qr}$  d,q axes secondary flux.

$R_s, R_r$  resistance of the primary and secondary windings respectively, per phase.

$\omega_e, \omega_r$  primary and secondary electrical frequency respectively.

$\omega_{sl}$  slip frequency.

$\tau_p$  pole pitch.

$L_m$  mutual inductance.

$L_s, L_r$  primary and secondary self inductances respectively, per phase.

$L_{ls}, L_{lr}$  primary and secondary leakage inductances respectively, per phase.

$p$  differential operator  $d/dt$ .

$P$  number of pole pairs.

$F$  electromagnetic thrust force.

$D$  primary length.

$Q$  factor linked to the primary length.

$v$  velocity (m/s).

## 1- Introduction

The analysis of the linear induction motors (LIM's) seems to be very complicated when the LIM electromagnetic field theory is used, especially when the magnetizing inductance and resistance representing

the core-losses are taken into account. This analytical model, with such a theory, will also suffer so much when it is required to represent the end effects [1].

Since the primary of the LIM continuously enters a new secondary region, the new secondary region and its influence on magnetic field change the LIM's performance in comparison with the conventional induction motor [2]. These effects must be taken into consideration during entry and exit from the secondary, in respect to the primary and represent them carefully to obtain the LIM's equivalent electrical circuit. It is very important to notice that the LIM's equivalent circuit is the same as conventional induction motor when there is no relative movement between the primary, which can be seen as infinite, and the secondary. Hence the end effects will be relatively small.

The transient changes at the entry and exit ends as a function of the primary length are shown in Fig.(1) [3].

In this paper a dynamic model of LIM based on the dq-model of equivalent

electrical circuit is implemented and prepared for further study especially for the vector control drive systems for LIM's. During the modeling process it is assumed that the primary which is simply a rotary motor primary cut open and rolled flat.

## 2-Mathematical Model of LIM

A mathematical model is proposed by the following equations [4]:

$$v_{ds} = R_s i_{ds} + R_r f(Q)(i_{ds} + i_{dr}) + p\lambda_{ds} - \omega_e \lambda_{qs} \quad \dots\dots\dots(1)$$

$$v_{qs} = R_s i_{qs} + p\lambda_{qs} - \omega_e \lambda_{ds} \quad \dots\dots\dots(2)$$

$$v_{dr} = R_r i_{dr} + R_r f(Q)(i_{ds} + i_{dr}) + p\lambda_{dr} - \omega_{sl} \lambda_{qr} \quad \dots\dots\dots(3)$$

$$v_{qr} = R_r i_{qr} + p\lambda_{qr} + \omega_{sl} \lambda_{dr} = 0 \quad \dots\dots\dots(4)$$

Where, the flux linkage components in (1)-(4) are given by:

$$\lambda_{ds} = L_{ls} i_{ds} + L_m (1 - f(Q))(i_{ds} + i_{dr}) \quad \dots\dots\dots(5)$$

$$\lambda_{qs} = L_{ls} i_{qs} + L_m (i_{qs} + i_{qr}) \quad \dots\dots\dots(6)$$

$$\lambda_{dr} = L_{lr} i_{dr} + L_m (1 - f(Q))(i_{ds} + i_{dr}) \quad \dots\dots\dots(7)$$

$$\lambda_{qr} = L_{ls} i_{qr} + L_m (i_{qr} + i_{qs}) \quad \dots\dots\dots(8)$$

In the above equations

$$f(Q) = \frac{1 - e^{-Q}}{Q} \quad \dots\dots\dots(9)$$

Where

$$Q = \frac{DR_r}{(L_m + L_{lr})v} \quad \dots\dots\dots(10)$$

The Q factor is associated with the length of the primary, and to a certain degree, quantifies the end effects as a function of the primary, and to a certain degree, quantifies the end effects as a function of the velocity v as described by equation (10). Also the motor thrust force will be given as:

$$F_e = \frac{3}{2} \frac{\pi}{\tau_p} \frac{P}{2} (\lambda_{ds} i_{qs} - \lambda_{qs} i_{ds}) \quad \dots\dots\dots(11)$$

The LIM's primary and secondary dq-currents are separable into two portions, of which the first is independent of the end effects, and the second dependent of the end effects. With this approach, the first portion behaves as a conventional induction motor current and the second portion as an attenuation function due to the LIM's end effects. The leakage fluxes are also separable into two parts, the first is independent of the end effects and will be denoted by the index-1, while the second describes the leakage flux dependent on the end effects, indicated by the index-2. The

equations representing these fluxes and currents are given in [5].

### 3-Simulation of LIM Using Simulink/Matlab Software Package

In this section extensive simulation results are presented to evaluate the dynamic performance of LIM. The parameters of the LIM used in the simulation are shown in Table (1).

Table (1)-Parameters of LIM

Number of pole pairs- $P=2$
$R_s=5.348 \Omega$
$R_r=11.603 \Omega$
$D=0.21 \text{ cm}$
$L_m=0.09213 \text{ H}$
$L_s=0.1073 \text{ H}$
$L_r=0.094618 \text{ H}$
$\tau_p=0.105 \text{ cm}$
Primary width-45 mm
Secondary thickness-4.5 mm
No. of slots-12
Air gap length-8 mm
Moment of inertia $-J=0.00247 \text{ Kgm}^2$

The simulink dynamic model used in this simulation and its internal construction are shown in Figs. (2) and (3). Figure (4) shows the LIM thrust force characteristics for no-load and several step change loading conditions. The velocity response for such loading conditions is shown in Fig. (5). The

synchronous reference frame dq-components of primary, secondary leakage fluxes and their two parts are shown through Figs. (6-9). While the dq-components of primary, secondary currents and their two parts in the synchronous reference frame are shown in Figs. (10-13). The motor line current of phase (a) is shown in Fig. (14). Note that the different leakage fluxes and currents are shown for the same sequence of loading conditions.

### 4- Conclusions

In this work a LIM simulink model modified into d-q frame is developed with the ability to represent its d-q currents and leakage fluxes (both for the primary and secondary) by two parts the first is independent of the end effects, and the second dependent of the end effects. Both flux and thrust coefficients were expressed with Q. The thrust force oscillations present in the LIM are caused by end effects, as can be seen in Fig. (2) which shows the requirement of a compensation scheme for that oscillation effects. The LIM model implemented is compatible to be used for vector control drives of LIM's. Such

driven schemes requirements for space-vector pulse width modulation controllers can be simplified with the d-q synchronized rotating reference frame voltage input ports of the implemented LIM model.

### 5- References

- 1- R. C. Creppe, C. R. de Souza, G. A. Simone, and P. J. A. Serni, "Dynamic behavior of a linear induction motor" MELECON 98, 9<sup>th</sup> Mediterranean Electro technical Conference, 1998, pages: 1047-1051, Vol. 2
- 2- G. Kang, and K. Nam, "Field-oriented control scheme for linear induction motor with end effects", IEE Proceedings-Electric Power Applications, Volume 152, Issue 6, 4 Nov. 2005, Pages: 1565-1572.
- 3- J. Atencia, M. Martinez, R. Garcia and J. Florez, "Modeling of linear induction motors as linear drives", IEEE proceedings on Power Tech, Vol. 4, 10-13 Sep. 2001 Pages: 5-7.
- 4- M. A. Nasr Khoidja, B. Ben Salah and P. Brochet, " Fuzzy logic control for a single sided linear induction motor" , SPEEDAM 2006, IEEE International Symposium on Power Electronics, Electrical Drives, Automation and Motion. Pages: S37-1 to S37 -5.
- 5- E. F. da Silva, E. B. dos Santos, P.C. M. Machado, and M. A.A. de Oliveria, "Vector control for linear induction motor", IEEE International Conference on Industrial technology, 2003 pages: 518-523 Vol. 1.



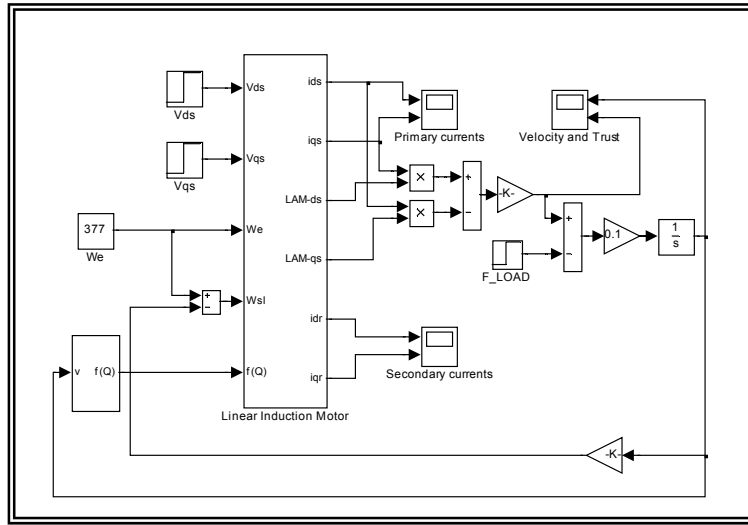

Fig. (3) Simulink model of the external ports and the mechanical attached load of LIM

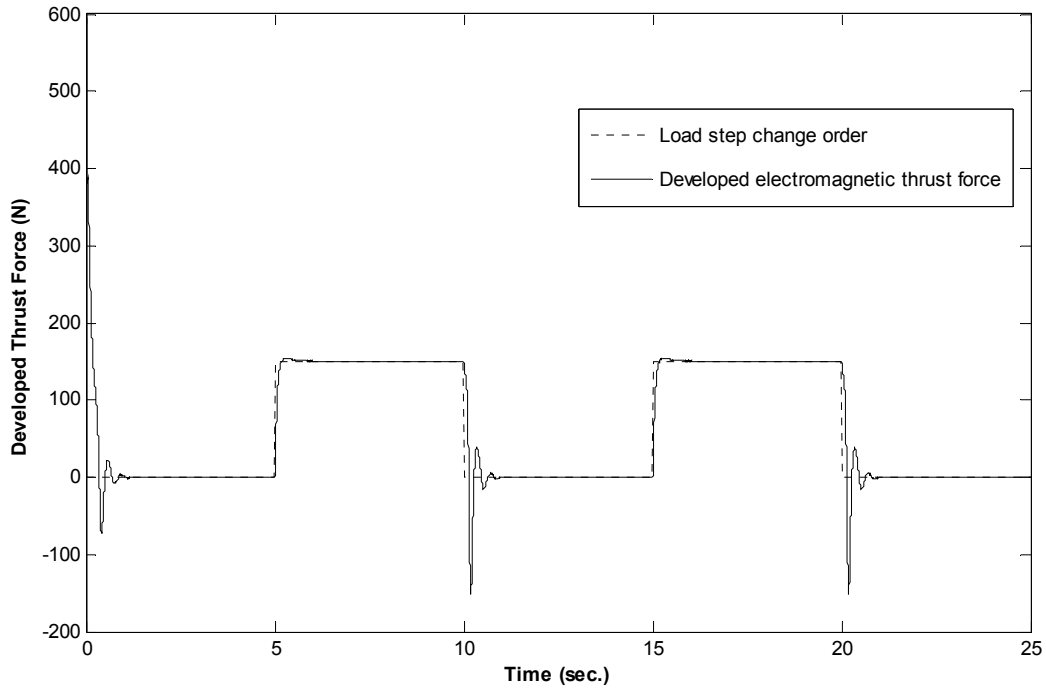

Fig. (4) Developed thrust force of the LIM

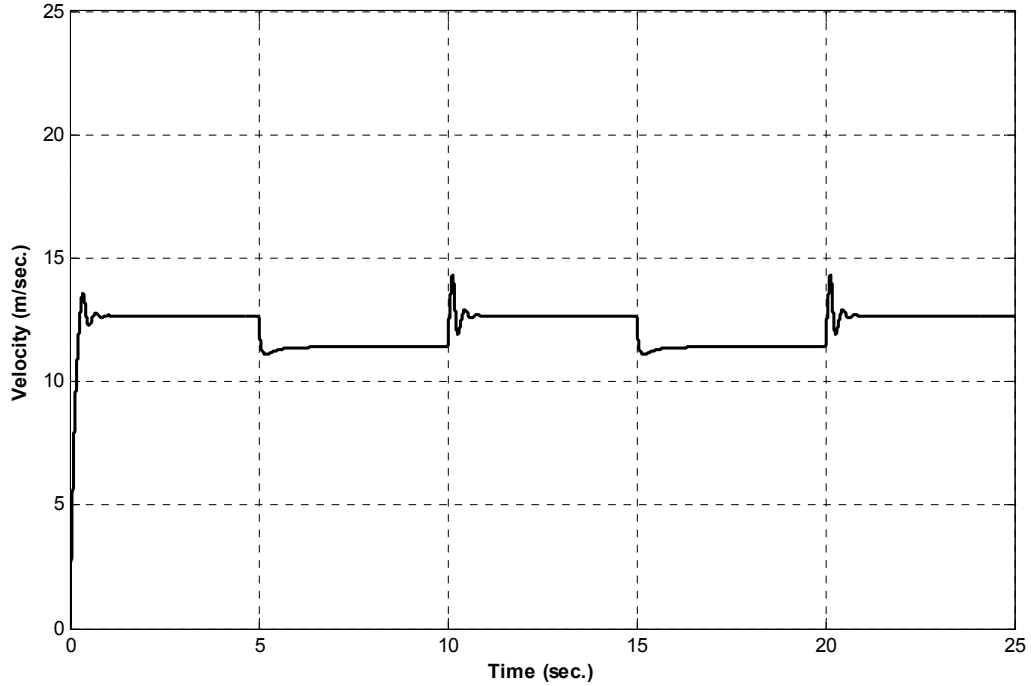

Fig. (5) Velocity of the LIM

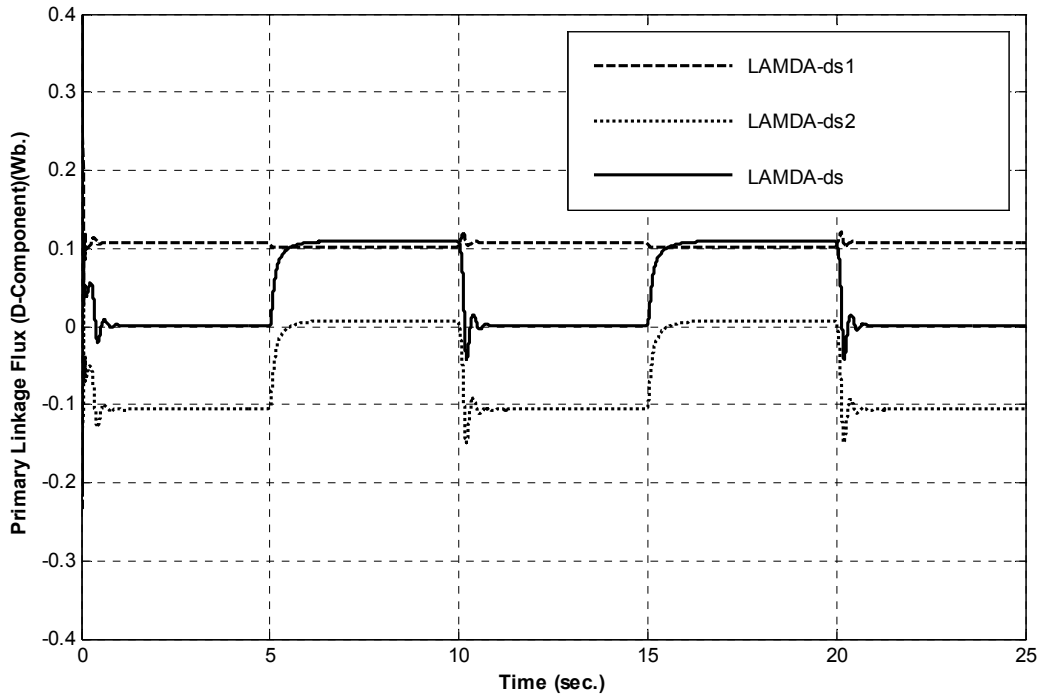

Fig. (6) Primary linkage flux (d-axis component and its two parts)



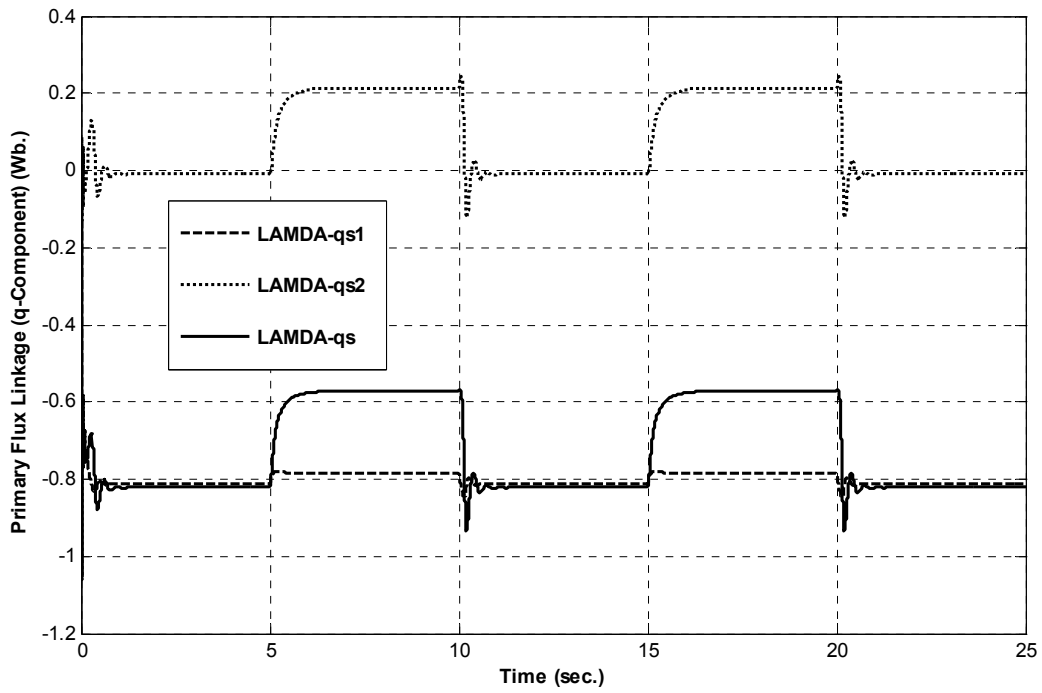

Fig. (7) Primary linkage flux (q-axis component and its two parts)

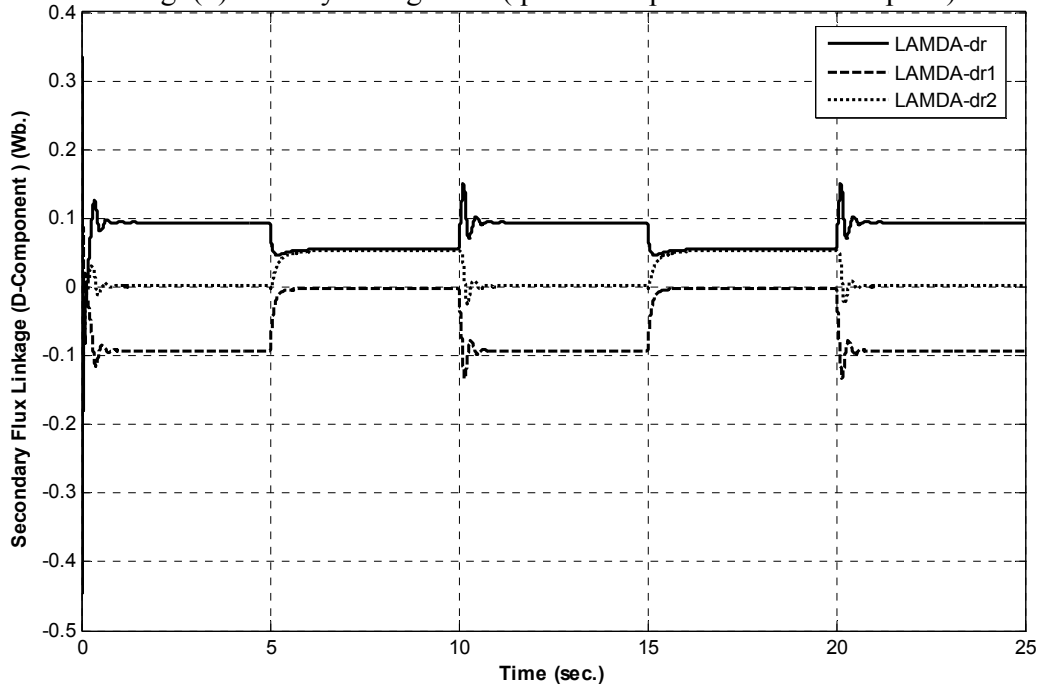

Fig. (8) Secondary linkage flux (d-axis component and its two parts)

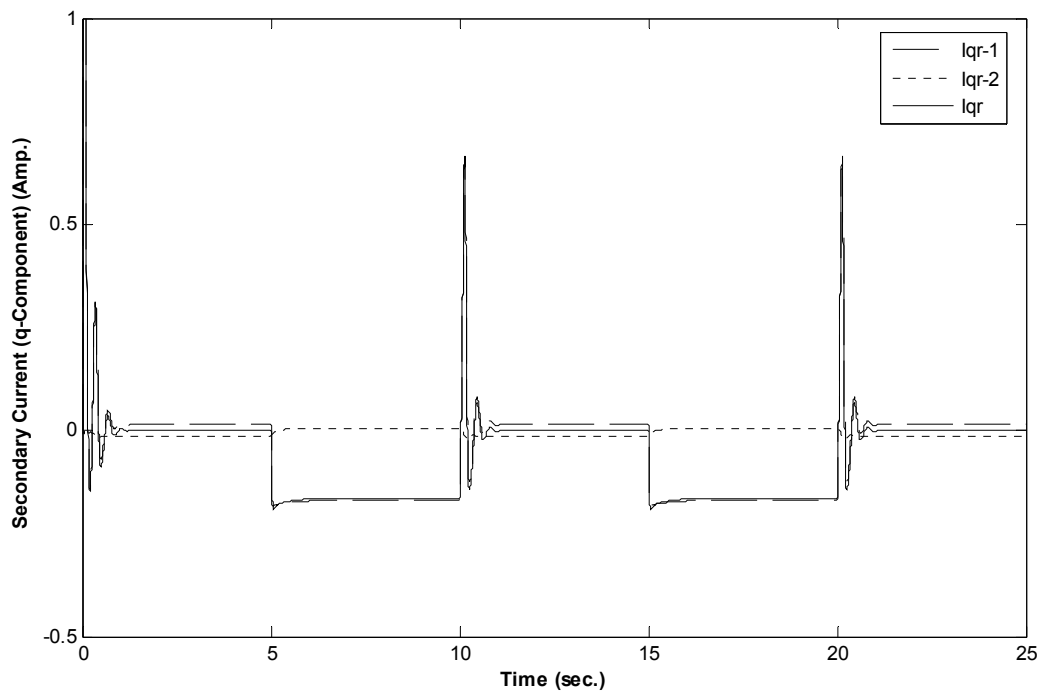

Fig. (9) Secondary linkage flux (q-axis component and its two parts)

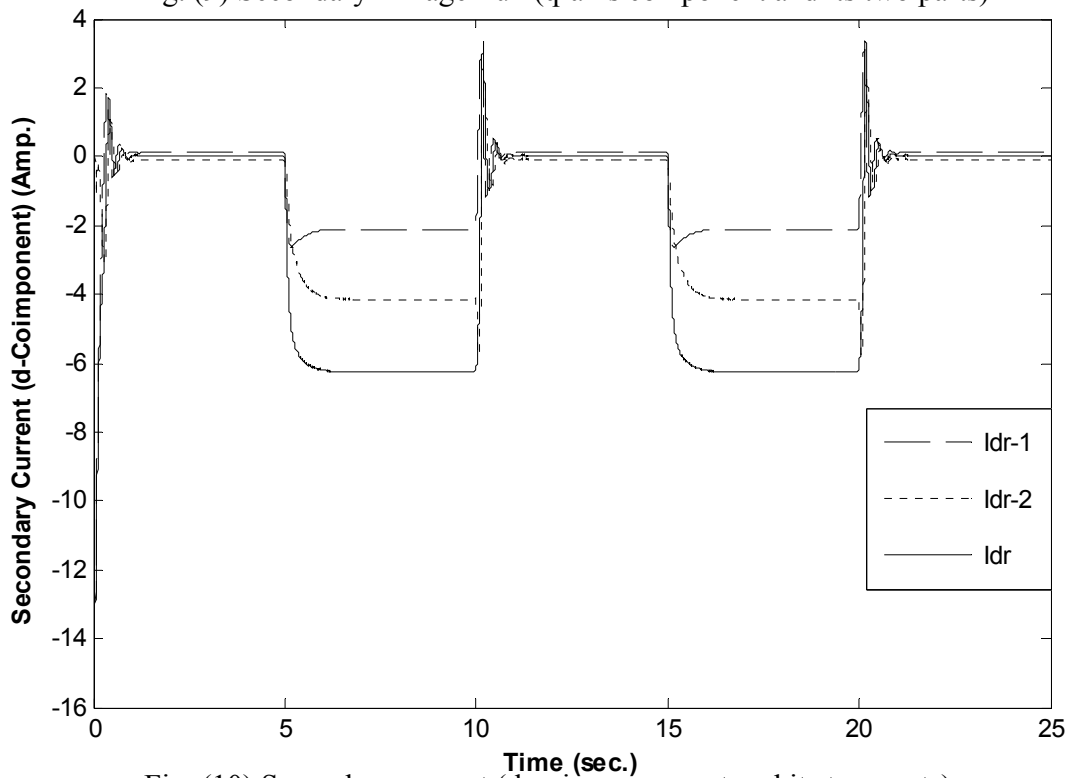

Fig. (10) Secondary current (d-axis component and its two parts)

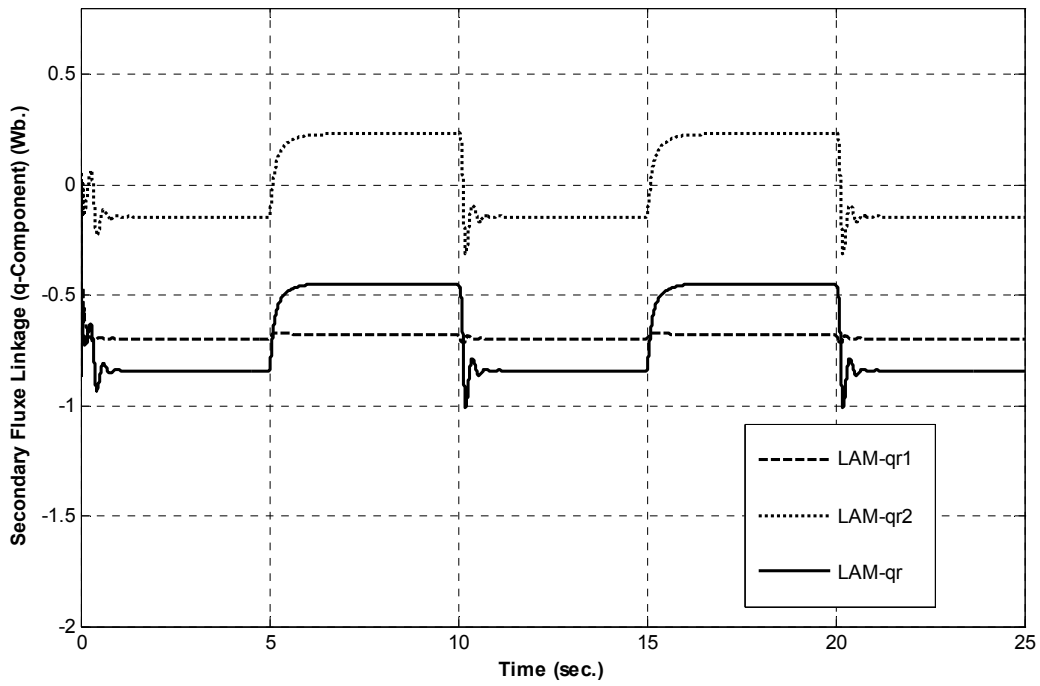

Fig. (11) Secondary current (q-axis component and its two parts)

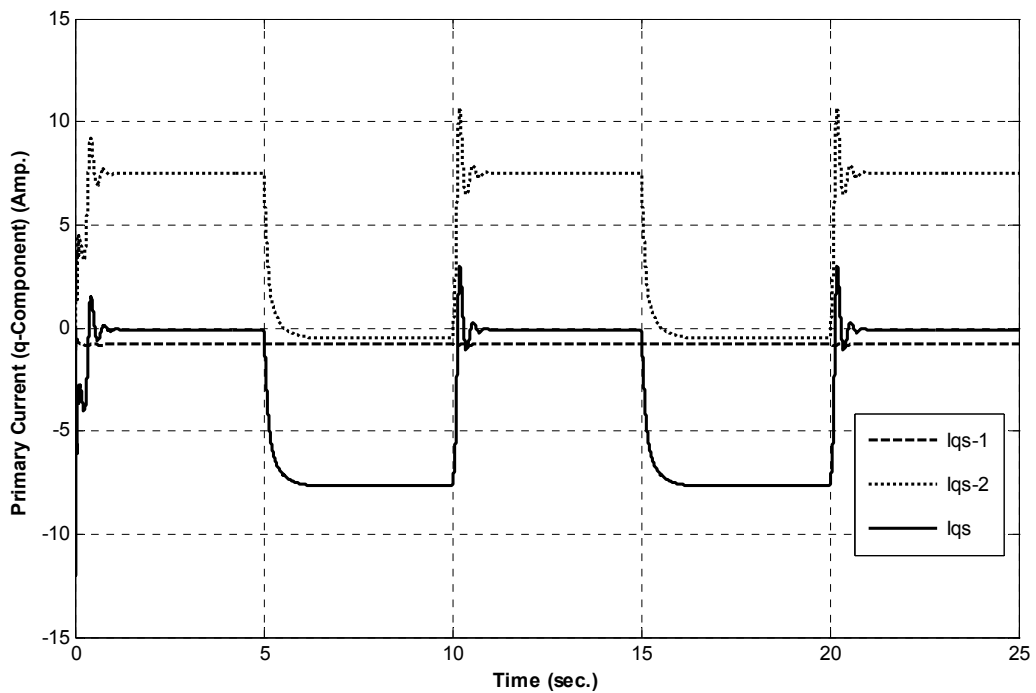

Fig. (12) Primary current (q-axis component and its two parts)

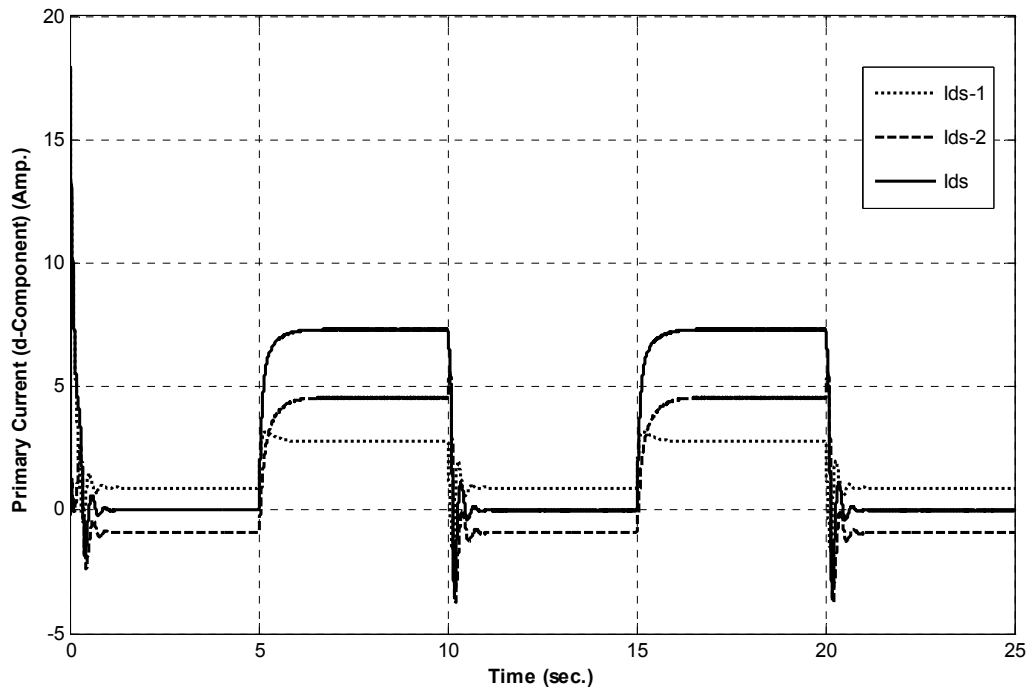

Fig. (13) Primary current (d-axis component and its two parts)

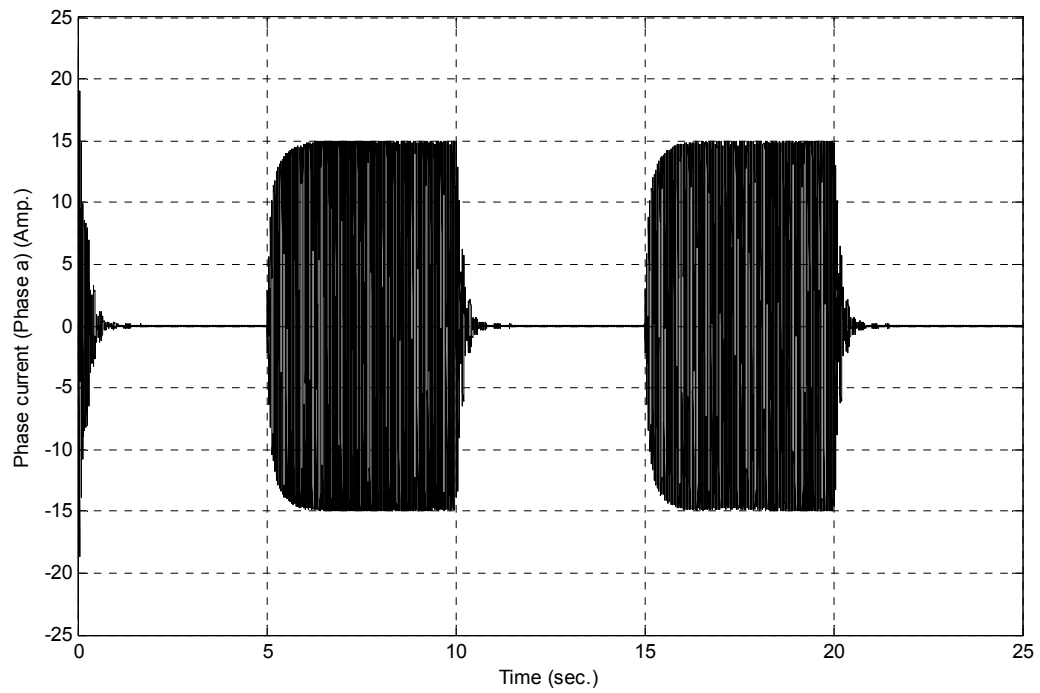

Fig. (14) LIM line current (Phase a)