

# Direct Torque Control System for a Three Phase Induction Motor With Fuzzy Logic Based Speed Controller

Turki Y. Abdalla  
Dept. of Computer Engineering  
College of Engineering  
University of Basrah

Haroutian Antranik Hairik  
Dept. of Computer Engineering  
College of Engineering  
University of Basrah

Adel M. Dakhil  
Dept. of Computer Engineering  
College of Engineering  
University of Basrah

**Abstract-**This paper presents a method for improving the speed profile of a three phase induction motor in direct torque control (DTC) drive system using a proposed fuzzy logic based speed controller. A complete simulation of the conventional DTC and closed-loop for speed control of three phase induction motor was tested using well known Matlab/Simulink software package. The speed control of the induction motor is done by using the conventional proportional integral (PI) controller and the proposed fuzzy logic based controller. The proposed fuzzy logic controller has a nature of (PI) to determine the torque reference for the motor. The dynamic response has been clearly tested for both conventional and the proposed fuzzy logic based speed controllers. The simulation results showed a better dynamic performance of the induction motor when using the proposed fuzzy logic based speed controller compared with the conventional type with a fixed (PI) controller.

## I. INTRODUCTION

Induction motors (IM) have been widely used in industry because of their advantages : simple , ruggedness reliability , low cost , and minimum maintenance. However , due to their highly coupled nonlinear structure , high-performance control of IM is a challenging problem [1].

It is now recognized that the two high performance control strategies for induction motor drives are field-oriented control (FOC) [2] ,[3] and direct torque control (DTC) [4] ,[5]. They have been invented respectively in the 70's and in the 80's. These control strategies are different on the operation principle but their objectives are the same [6].

These two methods are used to get high performance for induction motor . DTC can decouple the interaction between both torque and flux instantaneous errors , and provide good torque response in steady state and transient operation condition. This method have the advantages absence of coordinate transform , minimal torque response time , even better than the vector

controllers, in spite of this advantages this method have the following disadvantages like possible problems during starting , requirement of torque and flux estimators , implying the consequent parameters identification and the most disadvantages property for this method is inherent torque and flux ripples.

The most widely used controller in the industrial application are PID-type controllers because of their simple structure and good performance in a wide range of operating conditions [7]. The main problem of that simple controller is the correct choice of the PID gains , and the fact that by using fixed gains , the controller may not provide the required control performance , when there are variations in the plant parameters and operating conditions[8].

In this paper fuzzy logic based PI controller were introduced to eliminate the disadvantages of the PID controllers mention above , gain values of PI controller are adjusted on line. This controller provide the following advantages : dynamically adjust the gain  $K_p$  and  $K_i$  to ensure stability , soft speed response , reducing the speed overshoot , extremely small steady state errors.

## II. VECTOR MODEL OF INVERTER OUTPUT VOLTAGE

For three-phase VSI with three leg , there are 8-possible stator voltage vectors , to control the flux and torque to follow the reference values within hysteric's bands. The voltage space vector of a three phase system can be written as

$$\vec{V}_s(t) = \frac{2}{3}(V_{sa}(t) + aV_{sb}(t) + a^2V_{sc}(t)) \quad ..(1)$$

$$\text{where } a = e^{j\frac{2}{3}\pi} \quad ..(2)$$

$V_{sA}$  ,  $V_{sB}$  , and  $V_{sC}$  are the instantaneous phase voltages. From equation (1) above there are 6-non zero states and 2-null states as shown in figure (1) below

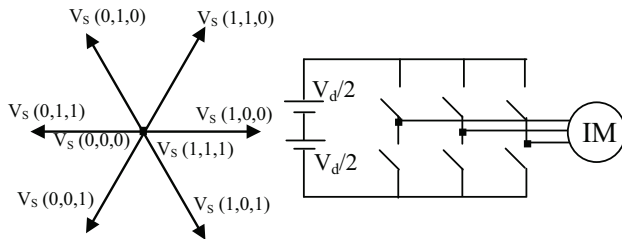

Fig.(1) Voltage Vectors for 3-Phase VSI

When using a DC-link voltage of  $V_d$ , the voltage space vector by using equation (1) is given by

$$V_s(t) = \frac{2}{3} V_d (S_a(t) + a S_b(t) + a^2 S_c(t)) \quad ..(3)$$

### III. INDUCTION MOTOR MODEL

The induction motor (IM) model in the fixed stator reference frame can be described by

$$\begin{bmatrix} V_{s\alpha} \\ V_{s\beta} \end{bmatrix} = R_s \begin{bmatrix} i_{s\alpha} \\ i_{s\beta} \end{bmatrix} + \begin{bmatrix} \frac{d\phi_{s\alpha}}{dt} \\ \frac{d\phi_{s\beta}}{dt} \end{bmatrix} \quad ..(4)$$

$$0 = R_r \begin{bmatrix} i_{r\alpha} \\ i_{r\beta} \end{bmatrix} + \begin{bmatrix} \frac{d\phi_{r\alpha}}{dt} \\ \frac{d\phi_{r\beta}}{dt} \end{bmatrix} - w_r \begin{bmatrix} 0 & -1 \\ 1 & 0 \end{bmatrix} \begin{bmatrix} \phi_{r\alpha} \\ \phi_{r\beta} \end{bmatrix} \quad ..(5)$$

where  $w_r$  is the rotor speed and under the assumptions of linearity and symmetry of electric and magnetic circuit and neglected iron losses, the magnetic equation are [1]

$$\phi_s = L_s i_s + M i_r \quad ..(6)$$

$$\phi_r = M \cdot i_s + L_r i_r \quad ..(7)$$

Where  $L_s$ ,  $L_r$  are the stator and rotor self-inductance, and  $M$  is the mutual inductance, and therefore the electrical torque can be expressed in term of stator and rotor fluxes as

$$T = \frac{M}{\sigma \cdot L_s \cdot L_r} \bar{\phi}_s^T \cdot J \cdot \phi_r = \frac{M}{\sigma \cdot L_s \cdot L_r} \|\phi_s\| \|\phi_r\| \sin \vartheta \quad ..(8)$$

where  $\sigma = 1 - \left( \frac{M^2}{L_s \cdot L_r} \right)$

$J$  = is the symmetric matrix

The mechanical dynamic equation is given by

$$\frac{dw_r}{dt} = \frac{1}{J_M} (T_e - T_L) \quad ..(9)$$

where  $J_M$  is the moment of inertia of the motor, and  $T_L$  is the load torque.

### IV. DIRECT TORQUE CONTROL

Direct torque control method was introduced in the middle of 8's decade by Isao Takahashi and Toshihiko Noguchi [9]. The principles of DTC method, selects one of the inverters six voltage vectors and two zero vectors in order to keep the stator flux and torque within a hysteric's band around the demand flux and torque magnitudes [9]. As shown above in Equation (8) which shows the torque produced is dependent on stator flux magnitude, rotor flux magnitude, and phase angle between the stator and rotor flux vectors. From equation (4) the induction motor equation can be approximated by ignored the stator resistance

$$\Delta \phi_s = \bar{V}_s \cdot \Delta t \quad ..(10)$$

Over a short period this means that the change in stator flux vector is determined by the applied voltage vector as shown in Figure( 1). If the torque and flux is kept within their hysteric's bands as shown in Figure (2) by selecting appropriate voltage vectors an independent control over the torque and stator flux is accomplished.

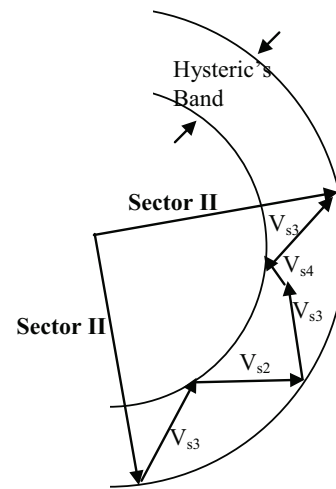

Fig.(2) Flux control within the hysteric's band

For stator flux is either increase or decrease and with torque is either increase, decreases or constant a table with 36 state can be constructed as [10]

Table (1) The switching table for the DTC

		Sector	1	2	3	4	5	6
Flux	Torque	$\Delta T = 1$	$V_2$	$V_3$	$V_4$	$V_5$	$V_6$	$V_1$
		$\Delta T = 0$	$V_7$	$V_0$	$V_7$	$V_0$	$V_7$	$V_0$
		$\Delta T = -1$	$V_6$	$V_1$	$V_2$	$V_3$	$V_4$	$V_5$
Flux	Torque	$\Delta T = 1$	$V_3$	$V_4$	$V_5$	$V_6$	$V_1$	$V_2$
		$\Delta T = 0$	$V_0$	$V_7$	$V_0$	$V_7$	$V_0$	$V_7$
		$\Delta T = -1$	$V_5$	$V_6$	$V_1$	$V_2$	$V_3$	$V_4$

V. STATOR FLUX ESTIMATOR

The issue of state estimation represents a major problem in the actual trend of the modern electrical machines control [12]

Thus to estimates the stator flux

$$\hat{\varphi}_s = \int (\bar{V}_s - R_{se} \cdot i_s) \cdot dt \quad \dots(11)$$

where :  $\hat{\phantom{x}}$  – represented the estimated value  
e – represented the estimator parameter

$\hat{\varphi}_s$  – the stator flux estimated value

$\bar{V}_s$  - Stator voltage

$R_{se}$  – the stator resistance estimator’s parameter

$i_s$  – stator current.

Figure (3) shows the simulated flux estimators ,

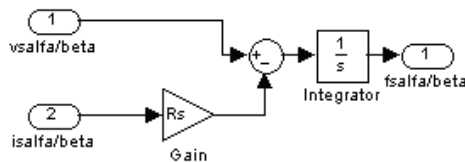

Fig.(3) Simulink Model for Flux Estimator

VI. FUZZY LOGIC BASED CONTROLLER

The PI-controller is represented by

$$u(k) = K_p \cdot e(t) + K_i \cdot \int e(t) \cdot dt \quad \dots(12)$$

where  $K_p$  and  $K_i$  are the proportional and integral gain factors. A block diagram of the fuzzy control system is shown in Fig.(4).

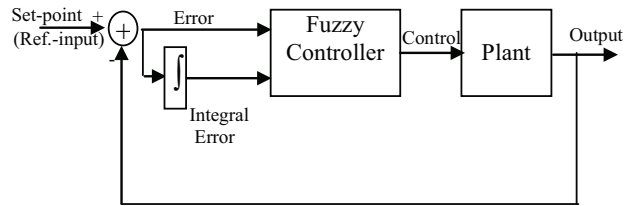

Fig.(4) A block diagram of a PI fuzzy control system (version one)

When the derivative , with respect to time ,of equation (12) is taken , it is transformed into an equivalent expression

$$\frac{du(t)}{dt} = K_p * \frac{de(t)}{dt} + K_i * e(t) \quad \dots(13)$$

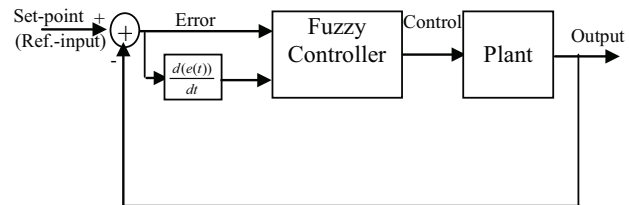

Fig.(5) A block diagram of a PD fuzzy control system (version two)

Let us consider this equation , the PD-controller for any pair of the values of error and change-of-error ( $\Delta e(t)$ ) calculates the control signal ( $u(t)$ ). The PD like fuzzy controller (shown in Fig.5)) should do the same thing. For any pair of error and change-of-error , it should work out the control signal. Then a PD-Like fuzzy controller consists of rules , and a symbolic description of each rule is given as

If  $e(t)$  is <property symbol> and  $\Delta e(t)$  is <property symbol > then  $u(t)$  is <property symbol>, where property symbol is symbolic name of a linguistic value. The natural language equivalent of the above symbolic description reads as follows for each sampling time t :  
If the value of the error is < linguistic value > and the value of change-of-error is <linguistic value> then the value of control output is <linguistic value> , the symbolic name of linguistic value mean a linguistic qualifiers,

determined for the proper variable : error , change-of-error or control signal , for example : high , low , medium , etc.

VII. STRUCTURE OF FUZZY LOGIC BASED SPEED CONTROLLER FOR DTC

Figure(6) shows the structure of the fuzzy PI-controller for direct torque control DTC. The main feature of this schemes is the fuzzy self-adaptation PI-controller block.

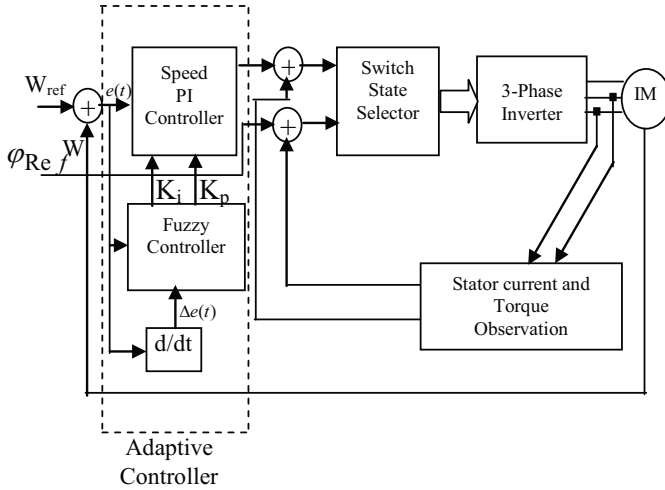

Fig. (6) Fuzzy PI-Controller Based DTC

In this method a scaled values of speed error and change-of-speed error are used by the fuzzy controller to updated the values of proportional gain  $K_p$  and integral gain  $K_i$  , by using a set of rules to have excellent control performance even for parameter variations and non-linearity characteristic of the drive system..

VIII. FUZZIFICATION OF INPUTS AND OUTPUTS OF THE FUZZY CONTROLLER

The universes range of the fuzzy controller's inputs, speed error and change of speed error, are characterized into seven and three overlapping fuzzy subsets respectively while the outputs, proportional gain and integral gain, into four overlapping fuzzy subsets. The use of the triangular shape for memberships is due to. According to this arrangement and due to the triangular shape of the membership functions used, there is always only one dominant fuzzy subset. The symbols used in memberships refers to the linguistic terms shown in tables (2-6).

Table(2) Linguistic term for error

Linguistic Term	Symbol
Negative Large	NL
Negative Medium	NM
Negative Small	NS
Zero Error	ZE
Positive Small	PS
Positive Medium	PM
Positive Large	PL

Table(3) Linguistic term for change-of-error

Linguistic Term	Symbol
Negative	N
Zero	Z
Positive	P

Table(4) Linguistic term for proportional gain and integral gain

Linguistic Term	Symbol
Zero	Z
Small	S
Medium	M
Large	L

Table(5) Fuzzy Control Linguistic Roles for Proportional Gain

$\Delta e(t)$ \ $e(t)$	NL	NM	NS	ZE	PS	PM	PL
N	L	M	S	M	S	M	L
Z	L	M	L	Z	L	M	L
P	L	M	L	Z	L	M	L

Table(6) Fuzzy Control Linguistic Roles for Integral Gain

$\Delta e(t)$ \ $e(t)$	NL	NM	NS	ZE	PS	PM	PL
N	Z	S	M	L	M	S	Z
Z	Z	S	M	L	M	S	Z
P	Z	M	L	L	L	M	Z

IX. FUZZY REASON AND DEFUZZIFICATION

The fuzzy reason rule  $R_i$  is defined as [13]

$$R_i : \text{if } e(t) = A_i \text{ and } \Delta e(t) = B_i \text{ Then } K_p = C_i \text{ and } K_i = D_i \dots(14)$$

Where variable  $A_i$  ,  $B_i$  ,  $C_i$  , and  $D_i$  are fuzzy subsets of speed error , change-of-speed error , proportional coefficient , and integral coefficient , respectively .  $i=1$

to 21 , there are 21 reason rule . Mamdani’s reason method is adopted to get the defuzzification output value can be acquired by using linear transform to the output value. The linear transform formula of proportional coefficient  $K_p$  and integral coefficient  $K_i$  is listed as follows

$$K_p = 20 + 0.8 \cdot (K_{po} - 2.5) \quad ..(15)$$

$$K_i = 0.0125 + 0.003 \cdot (K_{io} - 2.5) \quad ..(16)$$

where  $K_{po}$  ,  $K_{io}$  are the defuzzification value of  $K_p$  and  $K_i$  respectively

## XII. SIMULATION RESULTS

To examine the proposed scheme a model, using Matlab/Simulink software package have been implemented as shown in Fig.(7) and the induction motor used in this simulations has the parameters listed in table (7)

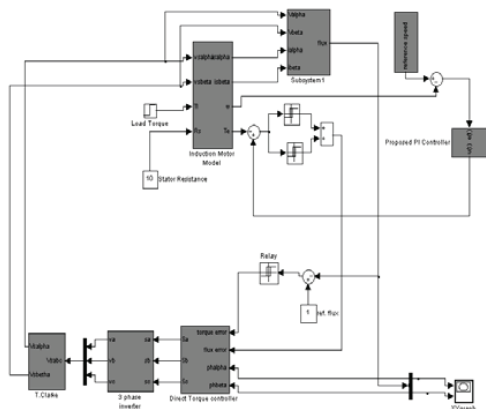

Fig.(7) Simulink model of the proposed system

Table (7) Rated data of the simulated induction motor

Rated Voltage	380 V
Maximum Torque	15 N.m.
Poles	4
Rated Speed	1440 RPM
Stator Resistance	1.2 $\Omega$
Rotor Resistance	1.8 $\Omega$
Stator Leakage Inductance	0.1554 H
Rotor Leakage Inductance	0.1568 H
Mutual Inductance	0.15 H
Moment of Inertia	1.662

Figure (8) shows the speed response for the classical direct torque control (CDTC) when using conventional PI-controller, and the induction motor initiates with out load and it is rotate by 150 rad/sec. Figure(9) shows the developed electromagnetic torque of this motor at this operating condition while Fig.(10) shows the same

response but now by using fuzzy PI-controller , it is obvious that oscillation has been canceled and the speed profile became smother. Figure(11) shows the associated developed electromagnetic torque when using fuzzy PI-controller for this motor.

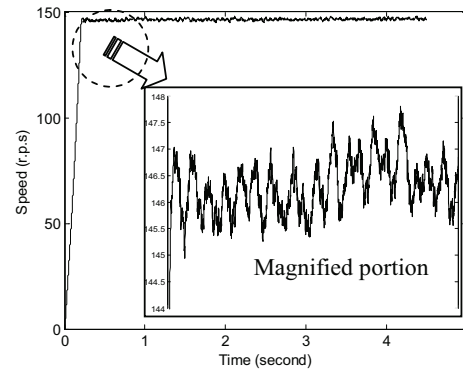

Fig.(8) speed response for the classical direct torque control by using conventional PI controller.

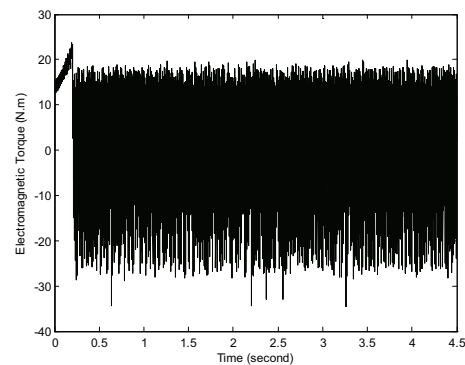

Fig.(9) Electromagnetic torque response for the classical direct torque control by using conventional PI controller. with a step change of speed from 0 to 150 (rad/sec.)

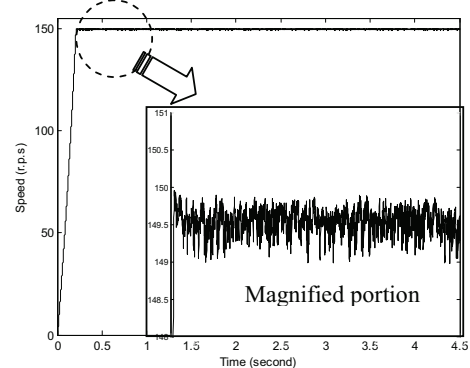

Fig.(10) Speed response for proposed fuzzy controller based DTC

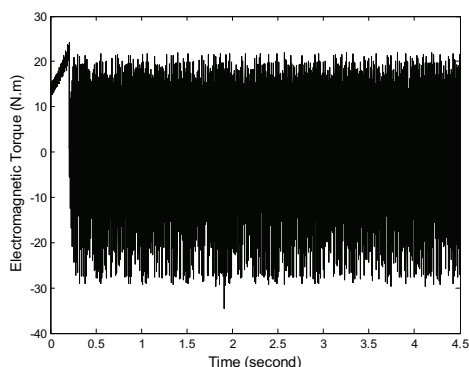

Fig.(11) Electromagnetic torque response for proposed fuzzy controller based DTC , with a step change of speed from 0 to 150 (r.p.s)

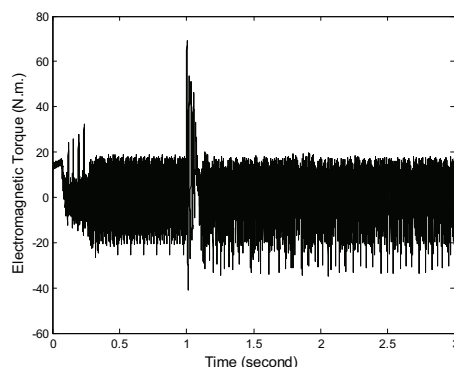

Fig.(13) Electromagnetic torque response for the classical DTC by using conventional PI controller. with a step change of speed from 0 to 50 and then to 100 (rad/sec) respectively

Figures (12) and (13) show the effect of step change in speed ,the first one give amount of overshoot much higher than the second. Figure(13) infers that it takes about 360 msec to reach steady state, while in Fig.(13) needs about 85 msec to reach the steady state , therefore fuzzy self-adaptation speed regulator accelerates the speed response and decrease the overshoot in the direct torque control

Figure (16) shows the speed response when a load torque is applied to this machine at 2 second using conventional PI-controller , and from this figure it is clear to note that , the speed is dropped to a value less than the no load speed while Fig.(18) shows speed response when using the proposed fuzzy controller, it is clear that the speed is almost constant when load torque is applied.

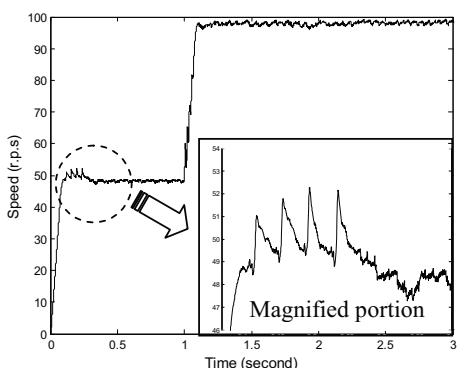

Fig.(12) Speed response under step change in speed for the classical DTC by using conventional PI controller

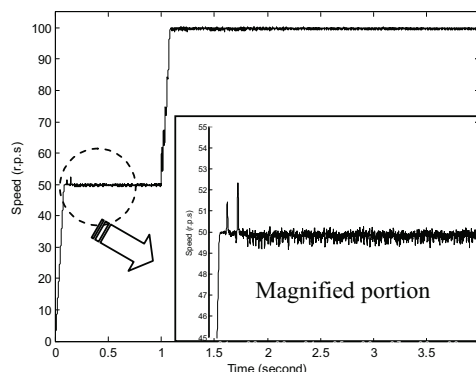

Fig.(14) Speed response under step change in speed for the proposed Fuzzy controller

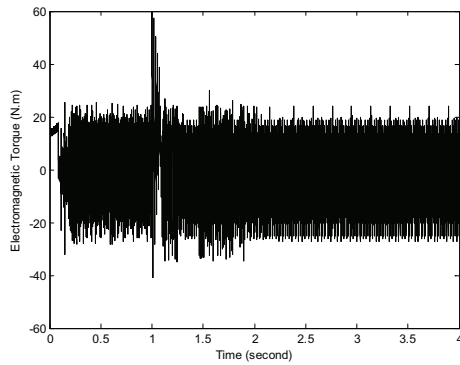

Fig.(15) Electromagnetic torque response for proposed fuzzy controller based DTC with a step change of speed from 0 to 50 and then to 100 (rad/sec) respectively

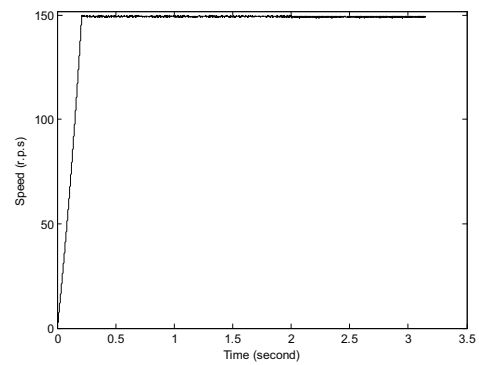

Fig.(18) Speed response for proposed fuzzy controller based DTC with a step change of load torque from 0 to 5 (N.m) at 2 second.

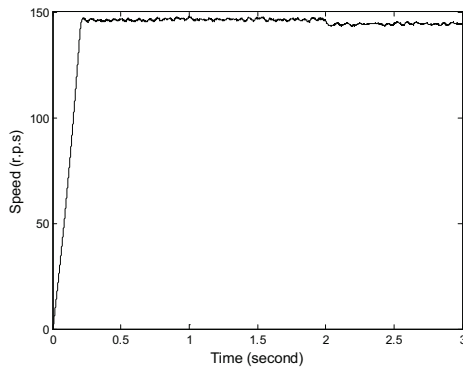

Fig.(16) speed response for the classical direct torque control with a step change of load torque from 0 to 5 (N.m) at 2sec.

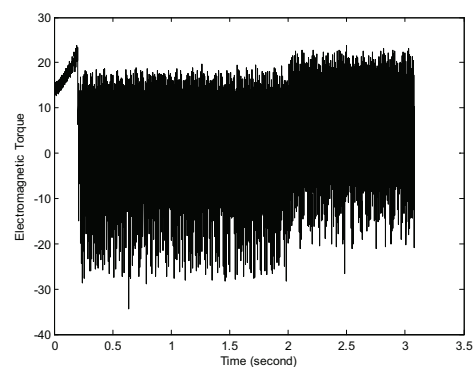

Fig.(19) Electromagnetic torque response for proposed fuzzy controller based DTC, with a step change of load torque from 0 to 5 (N.m) at 2 second.

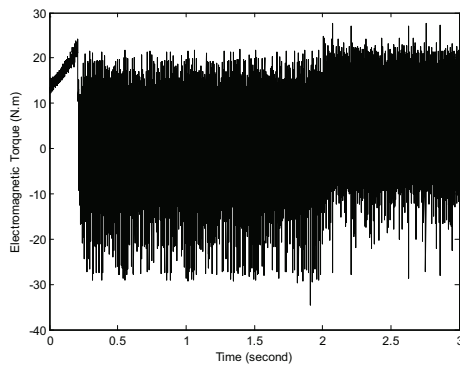

Fig.(17) Electromagnetic torque response for the classical direct torque control with a step change of load torque from 0 to 5 (N.m) at 2 second

### XIII. CONCLUSION

This paper present a fuzzy self-adaptation speed controller to overcome the disadvantages of the classical PI-Controllers. This study has successfully demonstrated the design and implementation of the adaptive fuzzy based controller by neglecting overshoot in the speed response and minimizing the rise time compared with the same results obtained for the classical direct torque control system.

### References

- [1] wang huangang , Xu Wenli , Yang Geng , Li Jian “ Variable-structure torque control of induction motors using space vector modulation” , Electrical Engineering ( 87 , 2005 , pp. 93-102).
- [2] F. Blaschke, “ The principle of the field orientation as applied to the new trans-vector closed loop control for rotating machines “ Siemens Review , vol. 30 , no. 5 , , 1972 pp.217-220.
- [3] R. de Doncker and D.W. Novotny, “ the universal field oriented controller” , IEEE-IAS annual

- meeting conference record , October 1988 , pp. 450- 456.
- [4] M. Depenbork , “ Direct self control (DSC) of inverter-fed induction machine “ , IEEE Trans. On power electronics , vol. PE-3 , no. 4 , October 1988 , pp. 420-429.
- [5] T. G. Habetler and D. J. Divan, “ Control strategies for direct torque control using discrete pulse modulation “ IEEE Trans. On industry application , vol. 27 , no.5 , September / October 1991 , pp. 893-901.
- [6] Hoang LE-Huy , “ Comparison of field-oriented control and direct torque control for induction motor drives “ , IEEE , 1999, pp. 1245-1252.
- [7] A. Hazzab , A. Laoufi , I.K. Bousserhane , M. Rahli , “ Real time implementation of fuzzy gain scheduling of PI controller for induction machine control “ , International Journal of Applied Engineering Research , vol.1 , no.1 , 2006 , pp. 51-60.
- [8] Shady M. Gadoue , D. Giaouris , J.W. Finch , “ Tuning of PI speed controller in DTC of induction motor based on genetic algorithms and fuzzy logic schemes” , IEEE , 2006, pp.
- [9] Isao Takahashi , Toshihiko Nogughi , “ A New quick –response and high efficiency control strategy of an induction motor” , IEEE Trans. on Industry Applications , vol. 1A-22 , no. 5 , September / October 1988 ,pp.820-827.
- [10] R. Toufouti , S. Meziane , H. Benalla , “ Direct torque control for induction motor using fuzzy logic” , ACSE Journal , Volume (6) , issue (2) , June , 2006.
- [11] . Leonard Reznik , “ Fuzzy controllers” Newnes,1997 , 83-86
- [12] .Josif Szeidert , Octavian Protean , Ioan Filip , Vasca Cristian , “ Considerations regarding the flux estimation in induction generator with application at the control of unconventional energetic conversion systems “
- [13] Jia-Qiang Yang , Jin Huang , “ Direct torque control system for induction motors with fuzzy speed PI regulator” , IEEE, Proceeding of the fourth international conference on machines learning and cybernetics ,Guangzhou , 18-21 August 2005, pp.778-783.